



## 1. Vorbereitungen



1

**Abb. 1:**  
Rollohalb-  
kassette  
und Ab-  
deckleisten  
auspacken

## 2. Reinigung der Fensterflächen



2



3

**Abb. 2, 3:**  
Mit dem Reini-  
gungstuch die  
zu verklebenden  
Flächen am Fen-  
sterflügel säu-  
bern (seitlich  
und oben die  
Glasleistendeck-  
flächen)

## 3. Montage - Halbkassette



4



5

**Abb. 4, 5:**  
An der Halbkas-  
sette  
(rückseitig) die  
Folie vom Klebe-  
band abziehen.

## 4. Halbkassette andrücken



6

**Abb. 6:**  
Kassette vorsich-  
tig andrücken  
und waagrecht  
ausrichten.



7

**Abb. 7:**  
Rollohalbkassette  
im oberen Klebe-  
bereich über die  
gesamte Breite  
fest andrücken

## 5. Montage - Abdeckprofil

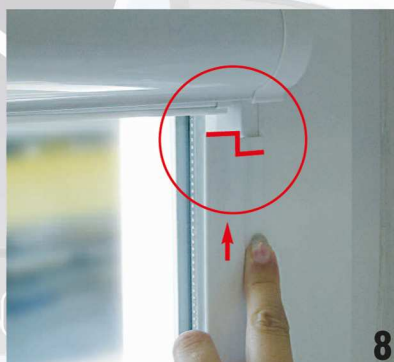

8



9

**Abb. 8, 9:**  
linkes und rechtes  
Abdeckprofil (ausgestanzte Seite ist  
oben) vorsichtig unter die Kassette  
bündig anschieben bis untere  
Höhe (**Abb. 9**) erreicht ist. Nun die  
Abdeckleiste fest andrücken.

Bitte wenden!

Montageanleitung Rollos ohne Bohren



## 6. Montage - Kettenbeschwerer

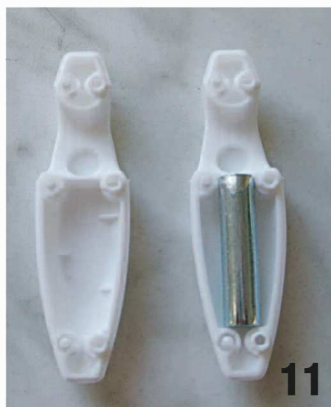

**Abb. 10:**  
Bedienkette richten.

**Abb. 11, 12:**  
Kettenbeschwerer wie in den Abbildungen montieren.

## 7. Kettenstopper anbringen



**Abb. 13, 14:**  
Obere und untere Endposition des Rollos mittels Stopper justieren.

**Abb. 15:**  
So sollte das Rollo hängen.

## Demontageanleitung

### Rückstandsfreie Entfernung



**Abb. 1, 2:**

Nehmen Sie einen Kunststoffschaber (z.B. einen Eiskratzer o.ä.) und drücken Sie diesen gemäß der Abbildungen vorsichtig entlang der Klebeflächen.

Danach entfernen Sie mit dem Kunststoffschaber die groben Klebebandrückstände.

Zum Schluss sprühen Sie die restlichen Rückstände mit dem Spezialreiniger von SOLARMATIC® ein. Lassen Sie diesen einige Minuten einwirken und wischen Sie die Rückstände danach mit einem Tuch ab.



Montageanleitung Rollos ohne Bohren